

MTMK5883

Operation Manual

V2.0



MICROSENSOR



Micro Sensor CO., LTD. reserves the right to modify this manual due to product technology and process updates. If there is any change, no further notice will be given.

Please pay attention to the latest version of this manual.

The company reserves the right of final interpretation of this manual.

Thank you very much for choosing the products of Micro Sensor CO., LTD. MTMK5883 Temperature Transmitting Controller belongs to precision instruments. To use the products better, please take some time to read this operation manual very carefully before using them.

1 Introduction

The MTMK5883 temperature transmitting controller is a fully digital measurement and control product that integrates temperature measurement, display, contact control, and transmitting output. It can be directly installed at the on-site temperature measurement point or on the control screen of the test bench. It can be set by pressing the button on site to set various parameters such as control points. It is widely used in the automatic control field of hydropower, metallurgy, and chemical industries to measure and control temperature.

2 Specifications

Power Supply: 18V~32V DC(Typical 24V DC)

8V~32V DC(Without current output)

Output: 4mA~20mA

4mA~20mA + 2-way relay

Accuracy: $\pm 0.5\%$ FS

Insulation Resistance: $\geq 50M\Omega@500VDC$

Load Capacity: 2-way relay 250V/3A(AC) or 30V/3A(DC)

Display: 4-digit LED display

Contact Life: $> 10^6$ times

Long-term Stability: $\pm 0.1\%$ FS/year

Environment Temperature: $-30^{\circ}\text{C}\sim 70^{\circ}\text{C}$

Medium Temperature: $-200^{\circ}\text{C}\sim 500^{\circ}\text{C}$

Storage Temperature: $-40^{\circ}\text{C}\sim 120^{\circ}\text{C}$

Probe Material: Stainless steel 304/316L/other

Housing Material: Cast aluminum housing IP65

3 Outline Structure

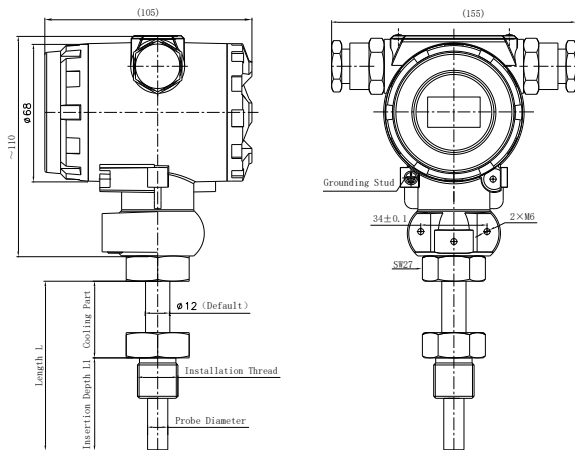

Fig. 1

4 Installation

4.1 Checking Before Installation

- a) The measuring range in site should be suitable with the measuring range of the transmitting controller;
- b) Please check if the installation and thread are suitable with the condition in site.

4.2 Electrical Connection

The electrical definition of the wiring terminal is shown in Figure 2 and Table 1, and the wiring method is shown in Figure 3.

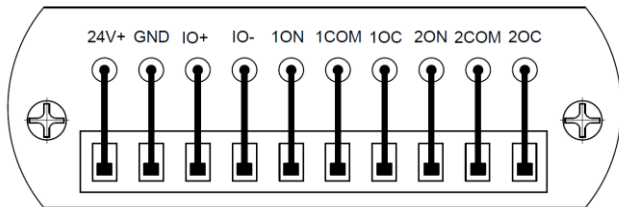

Fig. 2

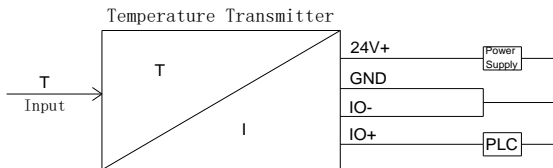

Fig. 3

Item	Definition
------	------------

24V+	24V V+
GND	24V V-
IO+	4-20mA Output +
IO-	4-20mA Output -
1ON	Relay 1 normally open terminal
1COM	Relay 1 GND terminal
1CN	Relay 1 normally closed terminal
2ON	Relay 2 normally open terminal
2COM	Relay 2 GND terminal
2CN	Relay 2 normally closed terminal

Table 1

5.5 Unpacking & Complete Set

5.1 Unpacking

- Check whether the package box is in good condition and set it down according to the “Upward” sign;
- Do not unpack it by force to avoid damaging products or accessories.

5.2 Complete Set

Shipment includes:

MTMK5883 Temperature Transmitting Controller 1pc

Operation Manual 1pc

Quality Certificate 1pc



5.3 Storage

The transmitter should be stored in the ambient temperature of $-20^{\circ}\text{C}\sim 70^{\circ}\text{C}$, the relative humidity is not more than 80% of the dry and ventilated room, indoor air does not contain corrosive substances to the transmitter.

6 Function Setting

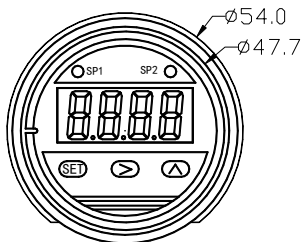
The setting of instrument includes 3 buttons, as followed:



Button	Name	Function
	Set	Confirm(Click) / Move cursor (long press)
	Up	Up / Increase the value
	Down	Down / Decrease the value

7 Manual Setting

Switch point setting process:

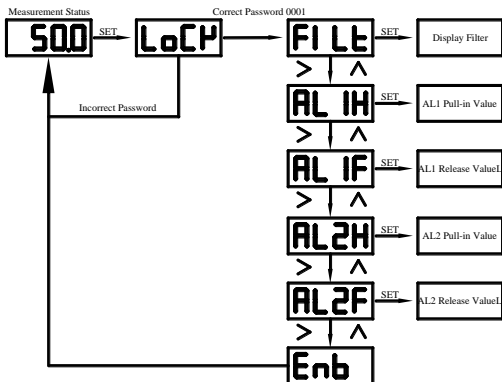

FILT This value is the display filter coefficient.

AL1H: This value is the pull-in value of switch 1 (AL1/SP1).

AL1F: This value is the release value of switch 1 (AL1/SP1).

AL2H: This value is the pull-in value of switch 2 (AL2/SP2) .

AL2F: This value is the release value of switch 2 (AL2/SP2).

END: Save and exit.

Note:

If $AL1H > AL1F$, then this SP1 is the upper limit alarm mode.

If $AL1H < AL1F$, then this SP1 is the lower limit alarm mode,

If $AL1H=AL1F$, then this SP1 is closed.

Return difference = Abs ($AL1H-AL1F$).

SP2 settings are the same as SP1.

Tip: If you accidentally enter the factory menu, and some parameters are changed, and the meter cannot work normally, please contact customer service or dealers to guide you to restore to the factory settings!

8 Installation Guide

MTMK5883 can be directly installed on the pipeline through a threaded interface. In critical applications (such as severe vibration or impact), the bellows can be used for mechanical decoupling.

To prevent the influence of electromagnetic interference, the following items should be paid attention to:

- The line connection should be as short as possible;
- Use shielded wire;
- Try to avoid direct access to the wiring of user devices, or electrical and electronic devices that cause interference;
- Pre-system power supply, isolated power supply is recommended.

9 Responsibility

Under the condition that the user abides by the use and protection rules, the instrument is guaranteed for one year from the date of shipment(except for overload or human factors, etc.). Micro Sensor welcomes users to send inquires at any time and make suggestions.

www.microsensor.cn



MICRO SENSOR CO.,LTD.

ADD:No. 18 Ying Da Road, Baoji City, Shaanxi Province

Tel: +86-(0)917-3600739/909 400 860 0606

Fax:0917-3600755

E-mail:sales@microsensor.cn