

MPM4730/4700

Operation Manual



MICROSENSOR



Contents

1 Introduction.....	1
2 Specifications	1
3 Outline Construction and Installation.....	3
4 Electric Connection.....	8
5 Unpacking、 Components and Storage	14
6 Operation and Maintenance.....	15
7 Responsibility	16

Our company reserves the modification right for this operation manual due to renovation of production technology and craftwork.

If some information is changed, no more notice will be edited.

Please pay attention to the latest version.

Our company also reserves the right of final explanation for this manual.

Version: V1.0

Thank you very much for selecting Micro Sensor's product, please take some time to read this operation manual very carefully before using the product.

1 Introduction

MPM4730/4700 Intelligent Pressure Transmitter is the intelligent pressure/level measurement instrument. Using the most advantaged technologies and the latest achievements in scientific research in the world, it is famous for its compact size, good stability and wide range. The intelligent pressure transmitter is suitable for precise measurement and control for liquid pressure/level in all various fields.

The Explosion-proof version of MPM4700 is an intrinsic safe version, conforming the standard of GB3836.1-2010 and GB3836.4-2010. Explode sign is Exia IIBT6 Ga.

MPM4730 marine products conform to the requirements of CCS classification specification for steel sea-going ships (2018) and have obtained type approval. MPM4700 marine products conform to the requirements of CCS classification specification for steel sea-going ships (2006) and have obtained type approval.

2 Specification

Pressure Range: -100kPa...0kPa~10kPa...1000bar (4730)

0mH₂O~1mH₂O...200mH₂O (4700)

Overpressure: ≤2 times FS or 1100Bar(Min. value is valid)

Pressure Type: gauge, absolute, sealed gauge (4730)

gauge, absolute (4700)

Accuracy: Accuracy: $\leq \pm 0.1\%FS$ $\leq \pm 0.25\%FS$ $\leq \pm 0.5\%FS$

Note: The precision of products is related to the range of measurement, and the precision of products in different range is different.

Power Supply: 10V~28VDC(RS485 communication interface)

12V~30VDC(HART[□] communication protocol)

10V~12V(The Ann model, the security gate power

supply)

Signal Output: 4mA~20mA (2-wire) , RS485/HART(optional)

Compensated temperature:-10°C~70°C

Operation temp.: -30°C~80°C(4730 4-pin Plug,7-pin Plug)

-20°C~70°C (4730B2 ,4700, cable material: PE, PVC)

-20°C~80°C (4730B2 ,4700, cable material: PUR)

-20°C~60°C(Intrinsic safety)

Storage temp.: -40°C~85°C(4730 4-pin Plug,7-pin Plug)

-20°C~85°C (4730 Cable type ,4700)

Long-term Stability: $\pm 0.2\%FS$ (typical)

Baud rate: 1200、2400、4800、9600 bits/s are optional

Load Resistance:(U-10V)/0.02A(Ω)(RS485, 4mA~20mA DC output)

(U-12V)/0.02A(Ω)(HART)

RS485 bus line could connect with 99 transmitter.

Insulation: 100M Ω / 50V

Vibration: 20g (20~5000)Hz

Shock: 20g, 11ms

Protection: IP65 (4730 B1 & B2) 、 IP63 (4730 B3)

IP68 (4700 Transmitter part) 、 P65(Junction box part)

Cable: ϕ 7.5mm PVC or polyurethane cable with vented tube

Weight: \leq 250g (4700 No cable) \leq 230g (4730)

3 Outline dimension and Installation

3.1 Outline dimension

Unit:mm

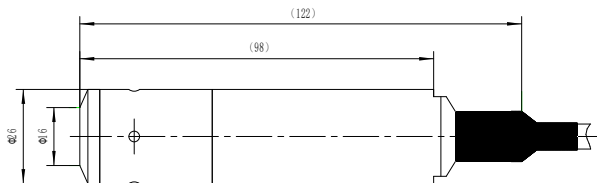

MPM4700

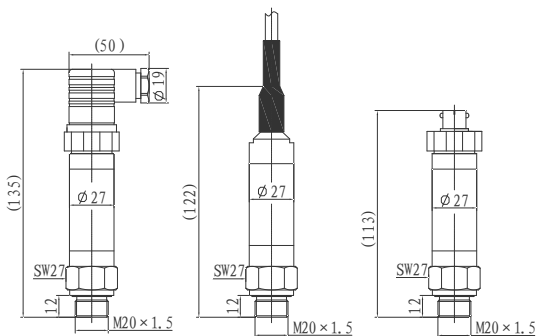

MPM4730 (B1)

MPM4730 (B2)

MPM4730 (B3)

3.2 Installation

3.2.1 Please be sure before Installation:

- The measuring pressure is in the measurement range;
- The measuring medium is compatible with construction material;
- The measuring medium would not stop up the pressure-leading hole.

hole.

3.2.2 Installation Method

Usually the transmitter should be mounted vertically up to the horizontal direction. If the condition is unavailable, the allowed max. mounted slope angle from transmitter to the horizontal direction is 30 degree.

Caution: do not poke the pressure-leading hole with hard things; and do not press the diaphragm with finger or something sharp to protect the diaphragm.

3.2.2.1 Recommended installation mode of pressure

products;

The pressure interface of the conventional pressure transmitter is M20×1.5 with sealing gasket; To facilitate installation and maintenance, a globe valve should be installed between the flange joint and the pipe, to see figure 1.

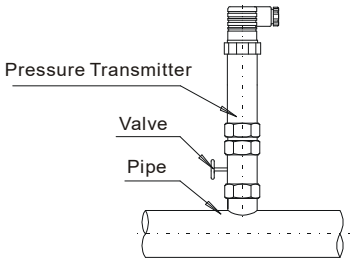

Figure 1

3.2.2.2 recommended installation method of liquid level products:

Installation in Static Water

- a) The installation method in the pool to see Figure 2. To protect the transmitter, it should be mounted far away from the pumping in/out source to prevent the pumping impact; the transmitter also could be mounted as Figure 3, protected by steel pipe.
- b) The installation method in the deep well to see Figure 3. Steel pipe inserting method could be used. The steel pipe could not be bent, the internal diameter $> 30\text{mm}$. Several little holes could be made at

different heights of the pipe for lifting up and down conveniently and making the water going through unobstructed. If necessary, the transmitter could be wrapped by steel wire. Lift up and down with the steel wire to protect the cable.

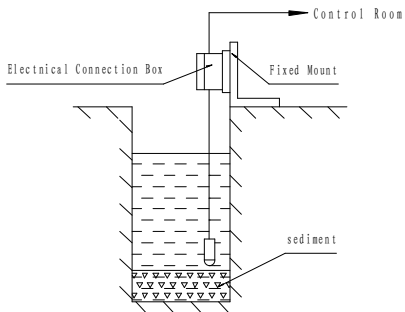

Fig. 2

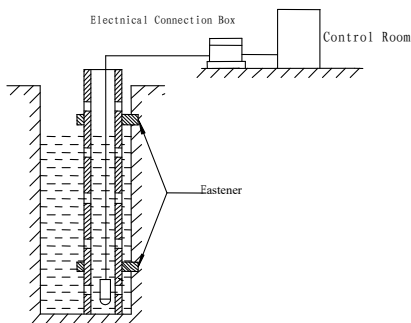

Fig. 3

Installation in the flowing water (e.g. river-way or reservoir) need water calming device.

- a) Inserting steel pipe in the water channel , The steel pipe should be thicker, and several little holes should be made at different heights of the pipe to damp wave and reduce water moving effect. (to see Figure 4)
- b) Superficial burying is better in the sand and stone channel.
(to see Figure 5)
- c) This method not only can dispel water flowing pressure and wave influence, but also can filter the sand and mud.(to see Figure 6)

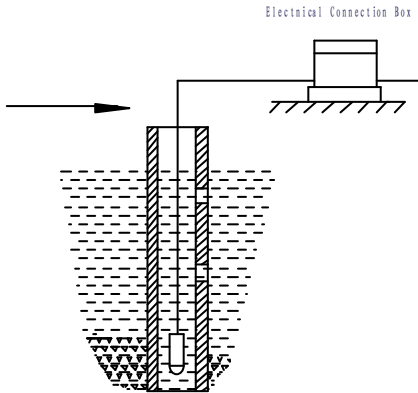

Fig. 4

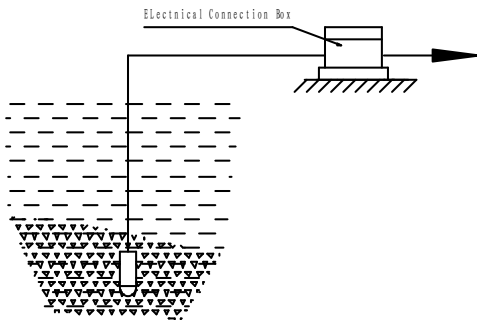

Fig. 5

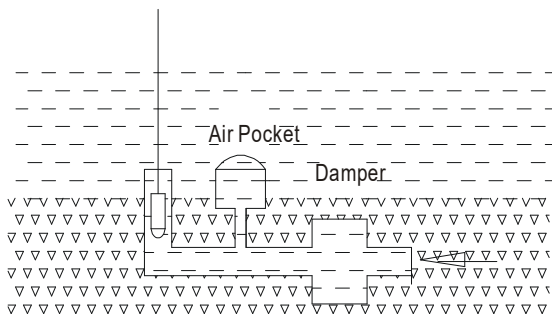



Fig. 6

4 Electric Connection

4.1 the transmitter is electrically connected with the external circuit through a plug socket or cable

Electric connection of non-explosion proof product	Definition	Internal Plug Wiring Color	External Plug Connection		
			4Wires Plug	MPM4730 B2 & MPM4700	7 Wires Plug
	+V	1 (Red)	1	Red	1
	OUT/GND	2 (Black)	2	Black	2
	RS 485B	4 (White)		White	5
	RS 485A	5 (Yellow)	3	Yellow(Green)	4

Electric connection of explosion proof product	Definition	Internal Plug Wiring Color	External Plug Connection		
			4Wires Plug	MPM4730 B2 & MPM4700	7 Wires Plug
	+V	1 (Red)	1	Red	1
	OUT/GND	2 (Black)	2	Black	2
	Case	3 (Blue)		Blue	7
	RS485B	4 (White)	-	White	5
	RS485A	5 (Yellow)	-	Yellow(Green)	4

Note: Explosion-proof product of 4-pin plug connection only provide (4 ~ 20) mA DC output

4.2 Typical electrical connection method

- a) The electric connection method of transmitter with 2-wire, 4mA~20mADC output to see Figure 7:

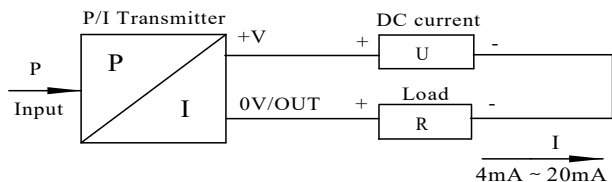

Fig. 7

b) The electric connection method of transmitter only with RS485 communication to see Figure 8:

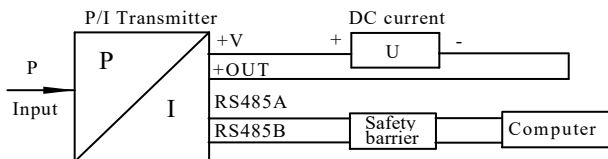

Fig. 8

Note: when 4mA ~ 20mA DC output and RS485 signal are used at the same time, RS485 signal will affect 4mA ~ 20mA DC output signal in communication, and the degree of influence is related to communication rate and communication frequency.

c) Wiring for HART transmitter connecting with hand-communicator. to see Figure 9:

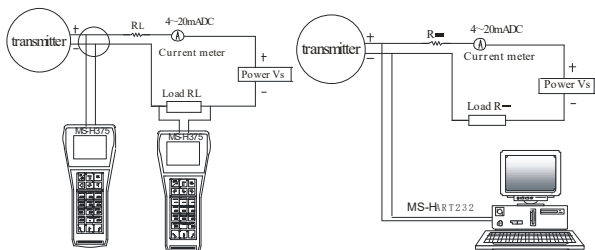

Fig. 9

- d) This Ann explosion-proof type electrical connection methods are shown below.

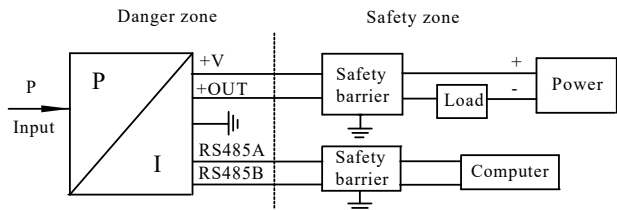

Fig. 10

ExialIBT6 Ga

[Exia]IIC

Transmitter Ex-proof parameter:

Safe barrier's ex-proof parameter:

Ui:12.4VDC li:140 mADC

Uo:12.4VDC lo:140mADC Po:0.43W

Li:0μH Ci:1.049μF Pi:0.43W

Note:

Ui: the highest input voltage, the highest voltage which could work on transmitter input terminals.

Uo: the highest output voltage, the highest voltage on intrinsically safe circuit when safe barrier's output side is open.

Ii: the max. input current, the max. current which could work on transmitter input terminals.

Io: the max. output current, the max. current on intrinsically safe circuit which could be got from safe barrier output terminals.

Ci: the max. internal capacitance, the internal equal total capacitance which could exist on transmitter input terminals.

Co: the max. external capacitance, the max. intrinsically safe capacitance which could be connected with safe barrier output terminals.

Li: the max. internal inductance, the internal equal total inductance which could exist on transmitter input terminals.

Lo: the max. external inductance, the biggest inductance which could be connected with safe barrier's terminals.

4.3 Installation notes

There is a plastic tube inside the cable, it is used to connect gauge sensor with the atmosphere. In the installation and operation, please be sure the vented tube connected with the atmosphere unobstructed. Please do not jam the vented tube with mud or sand, especially do not make water or other liquid going through the vented tube.

4.4 The connection of Explosion-proof version transmitter and safe barrier

- a) Then the intrinsic safe version transmitter is used in explosive environment, please connect the transmitter with the safe barrier to form Intrinsic Safe Ex-proof System.
- b) The installation of the intrinsic safe version transmitter should be conformed to the standard of GB3836.15-2000. Part 15 The Regulation of Electric Installation in Hazardous Area (except coal mine) of Electric Equipment Operation in Explosive Gas Environment.
- c) Then Intrinsic safe version transmitter is used in Hazardous Area, the power transformer which supplies the safe barrier should conform to the Regulation of GB3836.4-2010.
- d) Please install safe barrier and power in safe area, and install intrinsic safe transmitter in the hazardous area. Pay attention to grounding safely.
- e) The biggest permitted distributed capacitance for the cable between the transmitter and safe barrier connection is $C_p=C_o-C_i$, the biggest permitted distributed inductance $L_p=L_o-L_i$.
- f) Users can buy a safe barrier by yourself, only need to take care its specs are as above-mentioned requirements and have an explosion-proof certificate.
- g) The installation of safe barrier is in accordance with its operating instructions .

4.5 RS485 interface transmitter software

Transmitter software through RS232/RS485 conversion module, is used to communicate with RS485 interface (including level range, compensated temperature range and version), displaying actual pressure, setting new zero, analog output and transmitter address.

The initial address is random, if the user needs to reset the address, please notify us or reset it after receiving the product.

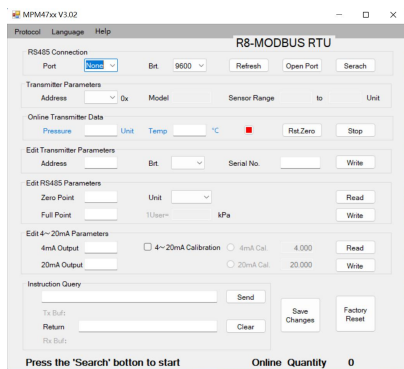

5 Unpacking, Shipment Enclosed and Storage

5.1 Unpacking

- Please be sure that the package is complete, and the package is put as the sign “UP”;
- Please be sure do not knock at the package violently, and protect the housing jacket and rubber bushing.

5.2 Shipment Enclosed

Transmitter out should include:

MPM4730/4700 Intelligent pressure/level Transmitter	1
Special Cable (connect to transmitter)	the length due to the order
Connection Box (connect to transmitter)	due to the order
User's Manual	1
Qualification Tracking Card	1
Converted Interface	due to the order
Software	due to the order

5.3 Storage

The transmitter shall be stored in a dry and ventilated room with a temperature of $-40^{\circ}\text{C} \sim 85^{\circ}\text{C}$ (4730 4-pin Plug,7-pin Plug), $-20^{\circ}\text{C} \sim 85^{\circ}\text{C}$ (4730 Cable type ,4700) and a relative humidity $\leq 85\%$. There is no corrosive gas in the indoor air to the transmitter.

6 Operation and Maintenance

6.1 Operation

Customers do not need to make any adjustments to the transmitter to put it into operation. Before putting into operation, please check the installation and electrical connection again. After confirming the correct electrical connection, switch on the power, preheat for 15min and put into operation.

6.2 Maintenance

MPM4730/4700 intelligent pressure/level transmitter does not need regular maintenance. However, please pay attention to the following items for better operation.

- a) Please check the cable connection often and make sure the cable connection reliably and no aging.
- b) Please clean the steel cap and diaphragm cavity according to the measuring media. (take care!)
- c) Please do not pull the cable violently or press the diaphragm with sharp or hard metal, etc.
- d) Please be sure the vented tube connected with the atmosphere unobstructed. Please do not jam the vented tube to prevent make additional error.

7 Responsibility

Within one year from the delivery date, we shall repair or replace the instrument with any quality fault caused by material parts or our manufacturing technique. For non-quality malfunction during user's operation, we are in charge of repair. But the material cost and the shuttle transportation fees should be borne by users.

www.microsensorcorp.com



MICRO SENSOR CO.,LTD.

ADD:No. 18 Ying Da Road, Baoji City, Shaanxi Province

Tel: +86-(0)917-3600739/909 400 860 0606

Fax:0917-3600755

E-mail:sales@microsensor.cn